

PCS Controllers

DIN-rail mounted softstarters up to 85A. Larger softstarter frame sizes up to 480A (400HP @480V)

D
PCS Softstarters

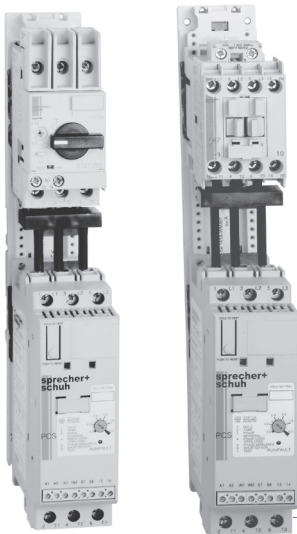

Sprecher + Schuh DIN-rail mounted Controllers can be direct connected to CA7 contactors to provide isolation or to KT7 Motor Circuit Controllers for branch circuit protection (for models up to 37A)

The PCS Softstarter Controller is Sprecher + Schuh's solid-state controller with rich features at an economical price. This softstarter is specifically designed to start 3-phase motors (up to 400HP@460V / 500HP@575V), but is very compact, easy to use and DIN-rail mountable for models up to 85A. Four standard starting modes are available with the PCS Controller:

- Soft Start
- Soft Start with Selectable Kick-Start
- Current Limit Starting
- Soft Start with Soft Stop

All PCS Softstarters are designed to control either a standard 3-phase squirrel-cage induction motor or a wye-delta motor (700HP @ 460V/900HP @ 575V Y-D).

For use anywhere

PCS Softstarters come in three different frame sizes. The smallest frame is from 3A...37A, the middle size is from 43A...85A and the largest frame size is 108A...480A. These units are available from 200V...600V - 50/60 Hz. This assures the devices can be used anywhere in the world.

Many convenient features

Easy Set-up – Digital rotary switches are quickly and easily set to the exact value. LED indication of all faults is standard.

Built-in Overload Protection – PCS Softstarters are equipped with electronic overload protection, accomplished with the use of current transformers on each of the three phases. Protection is programmable, providing total flexibility. Overload trip class selection includes OFF, 10, 15 or 20 seconds. In addition, either manual or automatic trip reset may be selected. Trip rating is 120% of dial setting.

Bypass Contactor – PCS controllers are equipped with a bypass contactor on each phase. Once the motor is up to speed, the load is removed from the SCRs, increasing their life and reducing heat.

Over Temperature Protection – The Softstarter monitors SCR temperature by means of internal thermistors. When the power poles maximum rated temperature is reached, the microcomputer switches off the PCS, a TEMP fault is indicated via LED, and the 97/98 fault contact closes.



Phase Reversal Protection – When enabled via a DIP-switch, 3-phase input power will be verified before starting. If input power phasing is detected to be incorrect, the start will be aborted and a fault indicated.

Phase Loss / Open Load – The PCS will not attempt to start if there is a single phase condition on the line. This protects from motor burnout during single phase starting.

Phase Imbalance – The unit monitors for imbalance between phase currents. To prevent motor damage, the unit will trip if the difference between the minimum phase current and the maximum phase current exceeds 65% for 3 seconds, and a fault will be indicated.

Shorted SCR – Prior to every start and during starting, the unit will check all SCRs for shorts and unit load connections to the motor. If there is a shorted SCR in the PCS and/or open load, the start will be aborted and a shorted SCR or open load fault will be indicated. This prevents damage from phase imbalance.

Push to Test – The unit with control wiring can be tested for fault conditions by using the Push to Test function. Hold down the Reset button for 7 seconds to activate the fault Aux (97, 98) and shut down the PCS. To clear, either push the Reset button or cycle control power to the device.

LED Description (Number of Flashes)

1. Overload
2. Overtemperature
3. Phase Reversal
4. Phase Loss/Open Load
5. Phase Imbalance
6. Shorted SCR
7. Test

Modes of Operation (Standard)

Soft Start	
	<p>This method has the most general application. The motor is raised from an initial torque value to full voltage. Initial torque is adjustable to 15%, 25%, 35% or 65% locked rotor torque. The motor voltage is gradually increased during the acceleration ramp time, which can be adjusted from 2, 5, 10, 15, 20, 25 or 30 seconds.</p>
Soft Start with Selectable Kickstart	
	<p>During the Soft Start phase, an initial kickstart or boost can be provided. This supplies a current pulse of 450% of full load current and is adjustable from 0.5 to 1.5 seconds. This allows the motor to develop additional torque for starting high inertia loads.</p>
Current Limit Starting	
	<p>This starting mode is used when it is desired to limit the maximum starting current (inrush). It can be adjusted for 150%, 250%, 350% or 450% of full load amps. Start times are selectable from 2, 5, 10, 15, 20, 25 or 30 seconds. If the motor is not up to speed after the selected time elapses, the controller transitions to full voltage.</p>
Soft Stop	
	<p>Soft Stop can be used for applications requiring an extended coast-to-rest, such as frictional type loads that tend to stop suddenly when voltage is removed from the motor. When enabled, the voltage ramp down time is equal to one, two or three times the start time selected. The load stops when the motor voltage drops to a point where the load torque is greater than the motor torque.</p>

D
PCS Softstarters

Open Type - Line Connected Controllers ②③⑤

Rated Voltage (V AC)	Current Rating (Amps) ①	Starting Duty		With 100...240V AC Control Voltage	With 24V AC/DC Control Voltage
		kW 50 Hz	Hp 60Hz	Catalog Number	Catalog Number
200/208	1...3	~	0.5	PCS-003-600V	PCS-003-600V-024
	3...9	~	0.75...2	PCS-009-600V	PCS-009-600V-024
	5.3...16	~	1.5...3	PCS-016-600V	PCS-016-600V-024
	6.3...19	~	1.5...3	PCS-019-600V	PCS-019-600V-024
	9.2...25	~	3...7.5	PCS-025-600V	PCS-025-600V-024
	10...30	~	3...7.5	PCS-030-600V	PCS-030-600V-024
	12.3...37	~	5...10	PCS-037-600V	PCS-037-600V-024
	14.3...43	~	5...10	PCS-043-600V	PCS-043-600V-024
	20...60	~	7.5...15	PCS-060-600V	PCS-060-600V-024
	28.3...85	~	10...25	PCS-085-600V	PCS-085-600V-024
	27...108	~	20...30	PCS-108-600V ④	PCS-108-600V-024 ④
	34...135	~	25...40	PCS-135-600V ④	PCS-135-600V-024 ④
	67...201	~	40...60	PCS-201-600V ④	PCS-201-600V-024 ④
	84...251	~	50...75	PCS-251-600V ④	PCS-251-600V-024 ④
	106...317	~	60...100	PCS-317-600V ④	PCS-317-600V-024 ④
	120...361	~	75...125	PCS-361-600V ④	PCS-361-600V-024 ④
160...480	~	100...150	PCS-480-600V ④	PCS-480-600V-024 ④	
230	1...3	0.55	0.5	PCS-003-600V	PCS-003-600V-024
	3...9	2.2	0.75...2	PCS-009-600V	PCS-009-600V-024
	5.3...16	4	1.5...5	PCS-016-600V	PCS-016-600V-024
	6.3...19	4	2...5	PCS-019-600V	PCS-019-600V-024
	9.2...25	5.5	3...7.5	PCS-025-600V	PCS-025-600V-024
	10...30	7.5	5...10	PCS-030-600V	PCS-030-600V-024
	12.3...37	7.5	5...10	PCS-037-600V	PCS-037-600V-024
	14.3...43	11	5...15	PCS-043-600V	PCS-043-600V-024
	20...60	15	7.5...20	PCS-060-600V	PCS-060-600V-024
	28.3...85	22	15...30	PCS-085-600V	PCS-085-600V-024
	27...108	30	20...40	PCS-108-600V ④	PCS-108-600V-024 ④
	34...135	37	25...50	PCS-135-600V ④	PCS-135-600V-024 ④
	67...201	55	40...75	PCS-201-600V ④	PCS-201-600V-024 ④
	84...251	75	50...100	PCS-251-600V ④	PCS-251-600V-024 ④
	106...317	90	60...125	PCS-317-600V ④	PCS-317-600V-024 ④
	120...361	110	75...150	PCS-361-600V ④	PCS-361-600V-024 ④
160...480	132	100...200	PCS-480-600V ④	PCS-480-600V-024 ④	

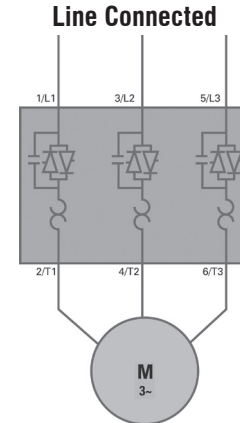

PCS Softstarters

- ① Motor FLA rating must fall within the specified current range for unit to operate properly. Special consideration should be given when using a motor with a potentially high starting current (greater than ten times motor FLA) with the PCS in the "Full Voltage" starting mode. The overload setting must be set to the motor FLA regardless if the Overload Function is "OFF" (disabled). Contact Sprecher+Schuh technical support for further guidance.
- ② See page D25 for maximum starts per hour.

- ③ Prior to the initial start of the motor at the final installation location:
 - The bypass relays on the main circuit may be in an undefined switching state due to handling during shipping. Before connecting the main power source, apply the control voltage to set the bypass relays to a defined switching state. If this step is not performed, inadvertent operation of the motor may occur.
- ④ Separate 120V or 240V single phase is required for PCS fan operation.
- ⑤ Controllers rated 108A and greater are not equipped with the line and load terminal lugs. See page D20 for terminal lug kits.

Open Type - Line Connected Controllers cont. ②③⑤

Rated Voltage (V AC)	Current Rating (Amps) ①	Starting Duty		With 100...240V AC Control Voltage	With 24V AC/DC Control Voltage
		kW 50 Hz	Hp 60Hz	Catalog Number	Catalog Number
380/400/ 415/460	1...3	1.1	0.5...1.5	PCS-003-600V	PCS-003-600V-024
	3...9	4	1.5...5	PCS-009-600V	PCS-009-600V-024
	5.3...16	7.5	5...10	PCS-016-600V	PCS-016-600V-024
	6.3...19	7.5	5...10	PCS-019-600V	PCS-019-600V-024
	9.2...25	11	7.5...15	PCS-025-600V	PCS-025-600V-024
	10...30	15	7.5...20	PCS-030-600V	PCS-030-600V-024
	12.3...37	18.5	10...25	PCS-037-600V	PCS-037-600V-024
	14.3...43	22	10...30	PCS-043-600V	PCS-043-600V-024
	20...60	30	15...40	PCS-060-600V	PCS-060-600V-024
	28.3...85	45	25...60	PCS-085-600V	PCS-085-600V-024
	27...108	55	50...75	PCS-108-600V ④	PCS-108-600V-024 ④
	34...135	75	60...100	PCS-135-600V ④	PCS-135-600V-024 ④
	67...201	95...110	75...150	PCS-201-600V ④	PCS-201-600V-024 ④
	84...251	95...132	100...200	PCS-251-600V ④	PCS-251-600V-024 ④
	106...317	95...160	125...250	PCS-317-600V ④	PCS-317-600V-024 ④
	120...361	110...200	250...300	PCS-361-600V ④	PCS-361-600V-024 ④
160...480	160...250	300...400	PCS-480-600V ④	PCS-480-600V-024 ④	
500/575	1...3	1.5	0.75...2	PCS-003-600V	PCS-003-600V-024
	3...9	5.5	3...7.5	PCS-009-600V	PCS-009-600V-024
	5.3...16	7.5	5...10	PCS-016-600V	PCS-016-600V-024
	6.3...19	11	7.5...15	PCS-019-600V	PCS-019-600V-024
	9.2...25	15	7.5...20	PCS-025-600V	PCS-025-600V-024
	10...30	18.5	10...25	PCS-030-600V	PCS-030-600V-024
	12.3...37	22	15...30	PCS-037-600V	PCS-037-600V-024
	14.3...43	22	15...40	PCS-043-600V	PCS-043-600V-024
	20...60	37	20...50	PCS-060-600V	PCS-060-600V-024
	28.3...85	55	30...75	PCS-085-600V	PCS-085-600V-024
	27...108	75	60...100	PCS-108-600V ④	PCS-108-600V-024 ④
	34...135	90	75...125	PCS-135-600V ④	PCS-135-600V-024 ④
	67...201	75...132	100...200	PCS-201-600V ④	PCS-201-600V-024 ④
	84...251	90...160	125...250	PCS-251-600V ④	PCS-251-600V-024 ④
	106...317	100...200	200...300	PCS-317-600V ④	PCS-317-600V-024 ④
	120...361	132...250	200...350	PCS-361-600V ④	PCS-361-600V-024 ④
160...480	200...315	250...500	PCS-480-600V ④	PCS-480-600V-024 ④	

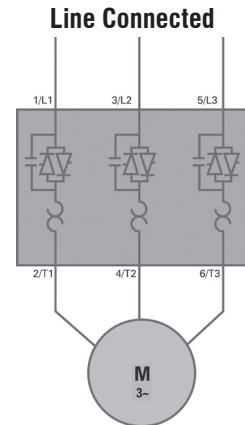

D
PCS Softstarters

- ① Motor FLA rating must fall within the specified current range for unit to operate properly. Special consideration should be given when using a motor with a potentially high starting current (greater than ten times motor FLA) with the PCS in the "Full Voltage" starting mode. The overload setting must be set to the motor FLA regardless if the Overload Function is "OFF" (disabled). Contact Sprecher+Schuh technical support for further guidance.
- ② See page D25 for maximum starts per hour.

- ③ Prior to the initial start of the motor at the final installation location:
 - The bypass relays on the main circuit may be in an undefined switching state due to handling during shipping. Before connecting the main power source, apply the control voltage to set the bypass relays to a defined switching state. If this step is not performed, inadvertent operation of the motor may occur.
- ④ Separate 120V or 240V single phase is required for PCS fan operation.
- ⑤ Controllers rated 108A and greater are not equipped with the line and load terminal lugs. See page D20 for terminal lug kits.

Open Type - Delta Connected Controllers ②④⑤

Rated Voltage (V AC)	Current Rating (Amps) ①	Starting Duty		With 100...240V AC Control Voltage	With 24V AC/DC Control Voltage
		kW 50 Hz	Hp 60Hz	Catalog Number	Catalog Number
200/208	1.7...5.1	~	1	PCS-003-600V	PCS-003-600V-024
	5.1...16	~	1.5...3	PCS-009-600V	PCS-009-600V-024
	9.1...27.6	~	3...7.5	PCS-016-600V	PCS-016-600V-024
	10.9...32.8	~	3...10	PCS-019-600V	PCS-019-600V-024
	14.3...43	~	3...10	PCS-025-600V	PCS-025-600V-024
	17.3...52	~	5...10	PCS-030-600V	PCS-030-600V-024
	21...64	~	7.5...20	PCS-037-600V	PCS-037-600V-024
	25...74	~	7.5...20	PCS-043-600V	PCS-043-600V-024
	34.6...104	~	15...30	PCS-060-600V	PCS-060-600V-024
	50...147	~	15...40	PCS-085-600V	PCS-085-600V-024
	47...187	~	20...60	PCS-108-600V ④	PCS-108-600V-024 ④
	59...234	~	20...75	PCS-135-600V ④	PCS-135-600V-024 ④
	116...348	~	75...100	PCS-201-600V ④	PCS-201-600V-024 ④
	145...435	~	100...150	PCS-251-600V ④	PCS-251-600V-024 ④
	183...549	~	100...200	PCS-317-600V ④	PCS-317-600V-024 ④
208...625	~	125...200	PCS-361-600V ④	PCS-361-600V-024 ④	
277...831	~	200...300	PCS-480-600V ④	PCS-480-600V-024 ④	
230	1.7...5.1	0.25...1.1	1	PCS-003-600V	PCS-003-600V-024
	5.1...16	1.1...4	1...5	PCS-009-600V	PCS-009-600V-024
	9.1...27.6	2.2...7.5	3...7.5	PCS-016-600V	PCS-016-600V-024
	10.9...32.8	2.2...7.5	3...10	PCS-019-600V	PCS-019-600V-024
	14.3...43	4...11	3...15	PCS-025-600V	PCS-025-600V-024
	17.3...52	4...15	5...15	PCS-030-600V	PCS-030-600V-024
	21...64	5.5...18.5	7.5...20	PCS-037-600V	PCS-037-600V-024
	25...74	5.5...22	7.5...25	PCS-043-600V	PCS-043-600V-024
	34.6...104	7.5...30	15...40	PCS-060-600V	PCS-060-600V-024
	50...147	15...45	20...50	PCS-085-600V	PCS-085-600V-024
	47...187	55	20...60	PCS-108-600V ④	PCS-108-600V-024 ④
	59...234	75	25...75	PCS-135-600V ④	PCS-135-600V-024 ④
	116...348	110	75...125	PCS-201-600V ④	PCS-201-600V-024 ④
	145...435	132	100...150	PCS-251-600V ④	PCS-251-600V-024 ④
	183...549	160	125...200	PCS-317-600V ④	PCS-317-600V-024 ④
208...625	200	150...250	PCS-361-600V ④	PCS-361-600V-024 ④	
277...831	250	200...300	PCS-480-600V ④	PCS-480-600V-024 ④	

Delta Connected

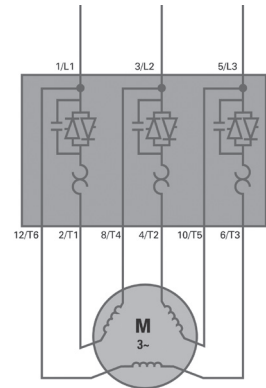

[All PCS Models are] Wye-Delta compatible

① Motor FLA rating must fall within the specified current range for unit to operate properly. Special consideration should be given when using a motor with a potentially high starting current (greater than ten times motor FLA) with the PCS in the "Full Voltage" starting mode. The overload setting must be set to the motor FLA regardless if the Overload Function is "OFF" (disabled). Contact Sprecher+Schuh technical support for further guidance.

② Prior to the initial start of the motor at the final installation location:
 – The bypass relays on the main circuit may be in an undefined switching state due to handling during shipping. Before connecting the main power source, apply the control voltage to set the bypass relays to a defined switching state. If this step is not performed, inadvertent operation of the motor may occur.

③ Separate 120V or 240V single phase is required for PCS fan operation.

④ Controllers rated 108A and greater are not equipped with the line and load terminal lugs. See page D20 for terminal lug kits.

⑤ It is recommended that an isolation contactor be added to the circuit to provide galvanic isolation of the motor and final electromechanical removal of power.

Open Type - Delta Connected Controllers cont. ②④⑤

Rated Voltage (V AC)	Current Rating (Amps) ①	Starting Duty		With 100...240V AC Control Voltage	With 24V AC/DC Control Voltage
		kW 50 Hz	Hp 60Hz	Catalog Number	Catalog Number
380/400/415/460	1.7...5.1	0.55...2.2	0.5...2	PCS-003-600V	PCS-003-600V-024
	5.1...16	2.2...7.5	2...7.5	PCS-009-600V	PCS-009-600V-024
	9.1...27.6	4...11	5...15	PCS-016-600V	PCS-016-600V-024
	10.9...32.8	4...15	5...15	PCS-019-600V	PCS-019-600V-024
	14.3...43	5.5...22	7.5...20	PCS-025-600V	PCS-025-600V-024
	17.3...52	7.5...22	7.5...30	PCS-030-600V	PCS-030-600V-024
	21...64	7.5...30	10...40	PCS-037-600V	PCS-037-600V-024
	25...74	11...37	10...50	PCS-043-600V	PCS-043-600V-024
	34.6...104	15...55	20...75	PCS-060-600V	PCS-060-600V-024
	50...147	22...75	25...100	PCS-085-600V	PCS-085-600V-024
	47...187	90	40...150	PCS-108-600V ④	PCS-108-600V-024 ④
	59...234	132	50...150	PCS-135-600V ④	PCS-135-600V-024 ④
	116...348	160	150...250	PCS-201-600V ④	PCS-201-600V-024 ④
	145...435	250	200...350	PCS-251-600V ④	PCS-251-600V-024 ④
	183...549	315	250...450	PCS-317-600V ④	PCS-317-600V-024 ④
	208...625	355	300...500	PCS-361-600V ④	PCS-361-600V-024 ④
277...831	450	350...700	PCS-480-600V ④	PCS-480-600V-024 ④	
500/575	1.7...5.1	0.75...3	1...3	PCS-003-600V	PCS-003-600V-024
	5.1...16	3...7.5	3...10	PCS-009-600V	PCS-009-600V-024
	9.1...27.6	5.5...15	7.5...20	PCS-016-600V	PCS-016-600V-024
	10.9...32.8	5.5...22	7.5...30	PCS-019-600V	PCS-019-600V-024
	14.3...43	7.5...22	10...40	PCS-025-600V	PCS-025-600V-024
	17.3...52	11...30	15...50	PCS-030-600V	PCS-030-600V-024
	21...64	11...37	15...60	PCS-037-600V	PCS-037-600V-024
	25...74	15...45	20...60	PCS-043-600V	PCS-043-600V-024
	84.6...104	22...55	30...100	PCS-060-600V	PCS-060-600V-024
	50...147	30...90	40...150	PCS-085-600V	PCS-085-600V-024
	47...187	132	50...150	PCS-108-600V ④	PCS-108-600V-024 ④
	59...234	160	60...200	PCS-135-600V ④	PCS-135-600V-024 ④
	116...348	250	250...300	PCS-201-600V ④	PCS-201-600V-024 ④
	145...435	315	250...400	PCS-251-600V ④	PCS-251-600V-024 ④
	183...549	400	300...500	PCS-317-600V ④	PCS-317-600V-024 ④
	208...625	450	350...600	PCS-361-600V ④	PCS-361-600V-024 ④
277...831	560	400...900	PCS-480-600V ④	PCS-480-600V-024 ④	

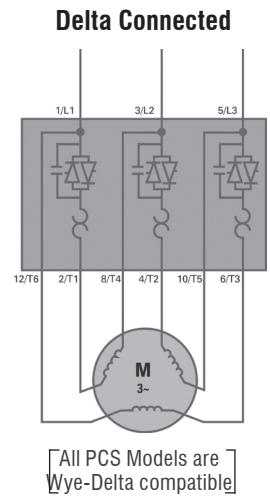

D
PCS Softstarters

- ① Motor FLA rating must fall within the specified current range for unit to operate properly. Special consideration should be given when using a motor with a potentially high starting current (greater than ten times motor FLA) with the PCS in the "Full Voltage" starting mode. The overload setting must be set to the motor FLA regardless if the Overload Function is "OFF" (disabled). Contact Sprecher+Schuh technical support for further guidance.
- ② Prior to the initial start of the motor at the final installation location:
 - The bypass relays on the main circuit may be in an undefined switching state due to handling during shipping. Before connecting the main power source, apply the control voltage to set the bypass relays to a defined switching state. If this step is not performed, inadvertent operation of the motor may occur.

- ④ Separate 120V or 240V single phase is required for PCS fan operation.
- ④ Controllers rated 108A and greater are not equipped with the line and load terminal lugs. See page D20 for terminal lug kits.
- ⑤ It is recommended that an isolation contactor be added to the circuit to provide galvanic isolation of the motor and final electromechanical removal of power.

Enclosed Non-Combination Starters - Line Connected ①②④⑥

Rated Voltage (V AC)	Current Rating (Amps) ⑤	Starting Duty		Type 12 [Type 3R ⑥] Industrial Dusttight Catalog Number	Type 4 Watertight Catalog Number
		kW 50 Hz	Hp 60Hz		
200/208	1...3	~	0.5	PCS-003-NHDD	PCS-003-NHDW
	3...9	~	0.75...2	PCS-009-NHDD	PCS-009-NHDW
	5.3...16	~	1.5...3	PCS-016-NHDD	PCS-016-NHDW
	6.3...19	~	1.5...3	PCS-019-NHDD	PCS-019-NHDW
	9.2...25	~	3...7.5	PCS-025-NHDD	PCS-025-NHDW
	10...30	~	3...7.5	PCS-030-NHDD	PCS-030-NHDW
	12.3...37	~	5...10	PCS-037-NHDD	PCS-037-NHDW
	14.3...43	~	5...10	PCS-043-NHDD	PCS-043-NHDW
	20...60	~	7.5...15	PCS-060-NHDD	PCS-060-NHDW
	28.3...85	~	10...25	PCS-085-NHDD	PCS-085-NHDW
	27...108	~	20...30	PCS-108-NHDD	PCS-108-NHDW
	34...135	~	25...40	PCS-135-NHDD	PCS-135-NHDW
	67...201	~	40...60	PCS-201-NHDD	PCS-201-NHDW
	84...251	~	50...75	PCS-251-NHDD	PCS-251-NHDW
	106...317	~	60...100	PCS-317-NHDD	PCS-317-NHDW
	120...361	~	75...125	PCS-361-NHDD	PCS-361-NHDW
160...480	~	100...150	PCS-480-NHDD	PCS-480-NHDW	
230	1...3	0.55	0.5	PCS-003-NADD	PCS-003-NADW
	3...9	2.2	0.75...2	PCS-009-NADD	PCS-009-NADW
	5.3...16	4	1.5...5	PCS-016-NADD	PCS-016-NADW
	6.3...19	4	2...5	PCS-019-NADD	PCS-019-NADW
	9.2...25	5.5	3...7.5	PCS-025-NADD	PCS-025-NADW
	10...30	7.5	5...10	PCS-030-NADD	PCS-030-NADW
	12.3...37	7.5	5...10	PCS-037-NADD	PCS-037-NADW
	14.3...43	11	5...15	PCS-043-NADD	PCS-043-NADW
	20...60	15	7.5...20	PCS-060-NADD	PCS-060-NADW
	28.3...85	22	15...30	PCS-085-NADD	PCS-085-NADW
	27...108	30	20...40	PCS-108-NADD	PCS-108-NADW
	34...135	37	25...50	PCS-135-NADD	PCS-135-NADW
	67...201	55	40...75	PCS-201-NADD	PCS-201-NADW
	84...251	75	50...100	PCS-251-NADD	PCS-251-NADW
	106...317	90	60...125	PCS-317-NADD	PCS-317-NADW
	120...361	110	75...150	PCS-361-NADD	PCS-361-NADW
160...480	132	100...200	PCS-480-NADD	PCS-480-NADW	

Non-Combination PCS Softstarters include:

- A 120V control power transformer with fused primary and secondary
- PCS built-in electronic motor overload protection
- PCS built-in SCR bypass/run contactor
- Available in UL Type 12 or 4 Enclosures
- Terminal blocks for remote control devices

D
PCS Softstarters

- ① Other UL type enclosures available. Contact your Sprecher + Schuh representative for pricing.
- ② See page D18 if ordering factory installed modifications.
- ③ The nominal current rating for the combination package may differ from the controller, based on the horsepower. Consult your Sprecher + Schuh representative.
- ④ Line and load termination are provided as standard.
- ⑤ For outdoor applications, replace "D" in catalog number with an "R". All enclosures are Type-12 with a Drip Shield. Example: PCS-085-NHDD becomes PCS-085-NHDR. **Price and dimensions remain the same.**

- ⑥ Motor FLA rating must fall within the specified current range for unit to operate properly. Special consideration should be given when using a motor with a potentially high starting current (greater than ten times motor FLA) with the PCS in the "Full Voltage" starting mode. The overload setting must be set to the motor FLA regardless if the Overload Function is "OFF" (disabled). Contact Sprecher+Schuh technical support for further guidance.

Enclosed Non-Combination Starters - Line Connected ①②④⑦

Rated Voltage (V AC)	Current Rating (Amps) ⑤	Starting Duty		Type 12 [Type 3R ⑥] Industrial Dusttight Catalog Number	Type 4 Watertight Catalog Number
		kW 50 Hz	Hp 60Hz		
460 ⑤	1...3	1.1	0.5...1.5	PCS-003-NBDD	PCS-003-NBDW
	3...9	4	1.5...5	PCS-009-NBDD	PCS-009-NBDW
	5.3...16	7.5	5...10	PCS-016-NBDD	PCS-016-NBDW
	6.3...19	7.5	5...10	PCS-019-NBDD	PCS-019-NBDW
	9.2...25	11	7.5...15	PCS-025-NBDD	PCS-025-NBDW
	10...30	15	7.5...20	PCS-030-NBDD	PCS-030-NBDW
	12.3...37	18.5	10...25	PCS-037-NBDD	PCS-037-NBDW
	14.3...43	22	10...30	PCS-043-NBDD	PCS-043-NBDW
	20...60	30	15...40	PCS-060-NBDD	PCS-060-NBDW
	28.3...85	45	25...60	PCS-085-NBDD	PCS-085-NBDW
	27...108	55	50...75	PCS-108-NBDD	PCS-108-NBDW
	34...135	75	60...100	PCS-135-NBDD	PCS-135-NBDW
	67...201	95...110	75...150	PCS-201-NBDD	PCS-201-NBDW
	84...251	95...132	100...200	PCS-251-NBDD	PCS-251-NBDW
	106...317	95...160	125...250	PCS-317-NBDD	PCS-317-NBDW
	120...361	110...200	250...300	PCS-361-NBDD	PCS-361-NBDW
160...480	160...250	300...400	PCS-480-NBDD	PCS-480-NBDW	
500/575	1...3	1.5	0.75...2	PCS-003-NCDD	PCS-003-NCDW
	3...9	5.5	3...7.5	PCS-009-NCDD	PCS-009-NCDW
	5.3...16	7.5	5...10	PCS-016-NCDD	PCS-016-NCDW
	6.3...19	11	7.5...15	PCS-019-NCDD	PCS-019-NCDW
	9.2...25	15	7.5...20	PCS-025-NCDD	PCS-025-NCDW
	10...30	18.5	10...25	PCS-030-NCDD	PCS-030-NCDW
	12.3...37	22	15...30	PCS-037-NCDD	PCS-037-NCDW
	14.3...43	22	15...40	PCS-043-NCDD	PCS-043-NCDW
	20...60	37	20...50	PCS-060-NCDD	PCS-060-NCDW
	28.3...85	55	30...75	PCS-085-NCDD	PCS-085-NCDW
	27...108	75	60...100	PCS-108-NCDD	PCS-108-NCDW
	34...135	90	75...125	PCS-135-NCDD	PCS-135-NCDW
	67...201	75...132	100...200	PCS-201-NCDD	PCS-201-NCDW
	84...251	90...160	125...250	PCS-251-NCDD	PCS-251-NCDW
	106...317	100...200	200...300	PCS-317-NCDD	PCS-317-NCDW
	120...361	132...250	200...350	PCS-361-NCDD	PCS-361-NCDW
160...480	200...315	250...500	PCS-480-NCDD	PCS-480-NCDW	

Non-Combination PCS Softstarters include:

- A 120V control power transformer with fused primary and secondary
- PCS built-in electronic motor overload protection
- PCS built-in SCR bypass/run contactor
- Available in UL Type 12 or 4 Enclosures
- Terminal blocks for remote control devices

D
PCS Softstarters

① Other UL type enclosures available. Contact your Sprecher + Schuh representative for pricing.

② See page D18 if ordering factory installed modifications.

③ The nominal current rating for the combination package may differ from the controller, based on the horsepower. Consult your Sprecher + Schuh representative.

④ Line and load termination are provided as standard.

⑤ For 380V applications choose softstarter based on FLA, then change the NB code in the catalog number to NG. For example PCS-043-NBDD becomes PCS-043-NGDD, which covers 25 HP @ 380V FLA 37. **Price remains the same.**

⑥ For outdoor applications, replace "D" in catalog number with an "R". All enclosures are Type-12 with a Drip Shield. Example: PCS-085-NBDD becomes PCS-085-NBDR. **Price and dimensions remain the same.**

⑦ Motor FLA rating must fall within the specified current range for unit to operate properly. Special consideration should be given when using a motor with a potentially high starting current (greater than ten times motor FLA) with the PCS in the "Full Voltage" starting mode. The overload setting must be set to the motor FLA regardless if the Overload Function is "OFF" (disabled). Contact Sprecher+Schuh technical support for further guidance.

Enclosed Combination Circuit Breaker Starters - Line Connected ①②④⑥

Rated Voltage (V AC)	Current Rating (Amps) Ⓞ	Starting Duty		Type 12 [Type 3R Ⓞ] Industrial Dusttight Catalog Number	Type 4 Watertight Catalog Number
		kW 50 Hz	Hp 60Hz		
200	3	—	0.5	PCS-003-BHD33D	PCS-003-BHD33W
	9	—	0.75	PCS-009-BHD34D	PCS-009-BHD34W
	9	—	1	PCS-009-BHD35D	PCS-009-BHD35W
	9	—	1.5	PCS-009-BHD36D	PCS-009-BHD36W
	16	—	2	PCS-016-BHD37D	PCS-016-BHD37W
	16	—	3	PCS-016-BHD38D	PCS-016-BHD38W
	25	—	5	PCS-025-BHD39D	PCS-025-BHD39W
	37	—	7.5	PCS-037-BHD40D	PCS-037-BHD40W
	43	—	10	PCS-043-BHD41D	PCS-043-BHD41W
	60	—	15	PCS-060-BHD42D	PCS-060-BHD42W
	85	—	20	PCS-085-BHD43D	PCS-085-BHD43W
	85	—	25	PCS-085-BHD44D	PCS-085-BHD44W
	108	—	30	PCS-108-BHD45D	PCS-108-BHD45W
	135	—	40	PCS-135-BHD46D	PCS-135-BHD46W
	201	—	60	PCS-201-BHD48D	PCS-201-BHD48W
	251	—	75	PCS-251-BHD49D	PCS-251-BHD49W
317	—	100	PCS-317-BHD50D	PCS-317-BHD50W	
361	—	125	PCS-361-BHD51D	PCS-361-BHD51W	
480	—	150	PCS-480-BHD52D	PCS-480-BHD52W	
230	3	0.37	0.5	PCS-003-BAD33D	PCS-003-BAD33W
	9	0.55	0.75	PCS-009-BAD34D	PCS-009-BAD34W
	9	0.75	1	PCS-009-BAD35D	PCS-009-BAD35W
	9	1.1	1.5	PCS-009-BAD36D	PCS-009-BAD36W
	9	1.5	2	PCS-009-BAD37D	PCS-009-BAD37W
	16	2.2	3	PCS-016-BAD38D	PCS-016-BAD38W
	25	3.7	5	PCS-025-BAD39D	PCS-025-BAD39W
	30	5.5	7.5	PCS-030-BAD40D	PCS-030-BAD40W
	37	7.5	10	PCS-037-BAD41D	PCS-037-BAD41W
	43	11	15	PCS-043-BAD42D	PCS-043-BAD42W
	60	15	20	PCS-060-BAD43D	PCS-060-BAD43W
	85	18.5	25	PCS-085-BAD44D	PCS-085-BAD44W
	85	22	30	PCS-085-BAD45D	PCS-085-BAD45W
	108	30	40	PCS-108-BAD46D	PCS-108-BAD46W
	135	37	50	PCS-135-BAD47D	PCS-135-BAD47W
	201	55	75	PCS-201-BAD49D	PCS-201-BAD49W
251	75	100	PCS-251-BAD50D	PCS-251-BAD50W	
317	90	125	PCS-317-BAD51D	PCS-317-BAD51W	
361	110	150	PCS-361-BAD52D	PCS-361-BAD52W	
480	147	200	PCS-480-BAD54D	PCS-480-BAD54W	

Combination Circuit Breaker PCS Softstarters include:

- A thermal magnetic circuit breaker with external operating handle
- A 120V control power transformer with fused primary and secondary
- PCS built-in electronic motor overload protection
- PCS built-in SCR bypass/run contactor
- Available in UL Type 12 or 4 Enclosures
- Terminal blocks for remote control devices

D PCS Softstarters

- ① Other UL type enclosures available. Contact your Sprecher + Schuh representative for pricing.
- ② See page D18 if ordering factory installed modifications.
- ③ The nominal current rating for the combination package may differ from the controller, based on the horsepower. Consult your Sprecher + Schuh representative.
- ④ See page D29 for circuit breaker ratings.
- ⑤ For outdoor applications, replace "D" in catalog number with an "R". All enclosures are Type-12 with a Drip Shield. Example: PCS-085-BHD43D becomes PCS-085-BHD43R. Price and dimensions remain the same.

- ⑥ Motor FLA rating must fall within the specified current range for unit to operate properly. Special consideration should be given when using a motor with a potentially high starting current (greater than ten times motor FLA) with the PCS in the "Full Voltage" starting mode. The overload setting must be set to the motor FLA regardless if the Overload Function is "OFF" (disabled). Contact Sprecher+Schuh technical support for further guidance.

Enclosed Combination Circuit Breaker Starters - Line Connected ①②④⑦

Rated Voltage (V AC)	Current Rating (Amps) ③	Starting Duty		Type 12 [Type 3R ⑥] Industrial Dusttight Catalog Number	Type 4 Watertight Catalog Number
		kW 50 Hz	Hp 60Hz		
460 ⑤	3	0.37	0.5	PCS-003-BBD33D	PCS-003-BBD33W
	3	0.55	0.75	PCS-003-BBD34D	PCS-003-BBD34W
	3	0.75	1	PCS-003-BBD35D	PCS-003-BBD35W
	9	1.1	1.5	PCS-009-BBD36D	PCS-009-BBD36W
	9	1.5	2	PCS-009-BBD37D	PCS-009-BBD37W
	9	2.2	3	PCS-009-BBD38D	PCS-009-BBD38W
	16	3.7	5	PCS-016-BBD39D	PCS-016-BBD39W
	16	5.5	7.5	PCS-016-BBD40D	PCS-016-BBD40W
	25	7.5	10	PCS-025-BBD41D	PCS-025-BBD41W
	30	11	15	PCS-030-BBD42D	PCS-030-BBD42W
	37	15	20	PCS-037-BBD43D	PCS-037-BBD43W
	43	18.5	25	PCS-043-BBD44D	PCS-043-BBD44W
	43	22	30	PCS-043-BBD45D	PCS-043-BBD45W
	60	30	40	PCS-060-BBD46D	PCS-060-BBD46W
	85	37	50	PCS-085-BBD47D	PCS-085-BBD47W
	85	45	60	PCS-085-BBD48D	PCS-085-BBD48W
	108	55	75	PCS-108-BBD49D	PCS-108-BBD49W
	135	75	100	PCS-135-BBD50D	PCS-135-BBD50W
201	110	150	PCS-201-BBD52D	PCS-201-BBD52W	
251	132	200	PCS-251-BBD54D	PCS-251-BBD54W	
317	160	250	PCS-317-BBD56D	PCS-317-BBD56W	
361	200	300	PCS-361-BBD57D	PCS-361-BBD57W	
480	250	400	PCS-480-BBD59D	PCS-480-BBD59W	
575	3	0.55	0.75	PCS-003-BCD34D	PCS-003-BCD34W
	3	0.75	1	PCS-003-BCD35D	PCS-003-BCD35W
	9	1.1	1.5	PCS-009-BCD36D	PCS-009-BCD36W
	9	1.5	2	PCS-009-BCD37D	PCS-009-BCD37W
	9	2.2	3	PCS-009-BCD38D	PCS-009-BCD38W
	9	3.7	5	PCS-009-BCD39D	PCS-009-BCD39W
	16	5.5	7.5	PCS-016-BCD40D	PCS-016-BCD40W
	16	7.5	10	PCS-016-BCD41D	PCS-016-BCD41W
	25	11	15	PCS-025-BCD42D	PCS-025-BCD42W
	30	15	20	PCS-030-BCD43D	PCS-030-BCD43W
	37	18.5	25	PCS-037-BCD44D	PCS-037-BCD44W
	43	22	30	PCS-043-BCD45D	PCS-043-BCD45W
	43	30	40	PCS-043-BCD46D	PCS-043-BCD46W
	60	37	50	PCS-060-BCD47D	PCS-060-BCD47W
	85	45	60	PCS-085-BCD48D	PCS-085-BCD48W
	85	55	75	PCS-085-BCD49D	PCS-085-BCD49W
	108	75	100	PCS-108-BCD50D	PCS-108-BCD50W
	135	90	125	PCS-135-BCD51D	PCS-135-BCD51W
201	132	200	PCS-201-BCD54D	PCS-201-BCD54W	
251	160	250	PCS-251-BCD56D	PCS-251-BCD56W	
317	200	300	PCS-317-BCD57D	PCS-317-BCD57W	
361	250	350	PCS-361-BCD58D	PCS-361-BCD58W	
480	315	500	PCS-480-BCD61D	PCS-480-BCD61W	

Combination Circuit Breaker

PCS Softstarters include:

- A thermal magnetic circuit breaker with external operating handle
- A 120V control power transformer with fused primary and secondary
- PCS built-in electronic motor overload protection
- PCS built-in SCR bypass/run contactor
- Available in UL Type 12 or 4 Enclosures
- Terminal blocks for remote control devices

D PCS Softstarters

① Other UL type enclosures available. Contact your Sprecher + Schuh representative for pricing.

② See from page D18 if ordering factory installed modifications.

③ The nominal current rating for the combination package may differ from the controller, based on the horsepower. Consult your Sprecher + Schuh representative.

④ See page D29 for circuit breaker ratings.

⑤ For 380V applications choose softstarter based on FLA, then change the BB code in the catalog number to BG. Example PCS-043-BBD44D becomes PCS-043-BGD44D, which covers 25 HP @ 380V FLA 37. **Price remains the same.**

⑥ For outdoor applications, replace "D" in catalog number with an "R". All enclosures are Type-12 with a Drip Shield. For example number PCS-085-BBD47D becomes PCS-085-BBD47R. **Price and dimensions remain the same.**

⑦ Motor FLA rating must fall within the specified current range for unit to operate properly. Special consideration should be given when using a motor with a potentially high starting current (greater than ten times motor FLA) with the PCS in the "Full Voltage" starting mode. The overload setting must be set to the motor FLA regardless if the Overload Function is "OFF" (disabled). Contact Sprecher+Schuh technical support for further guidance.

Enclosed Combination Fusible Starters - Line Connected ①②④⑥

Rated Voltage (V AC)	Current Rating (Amps) ③	Starting Duty		Type 12 [Type 3R ⑤] Industrial Dusttight Catalog Number	Type 4 Watertight Catalog Number
		kW 50 Hz	Hp 60Hz		
200	3	—	0.5	PCS-003-FHD33D	PCS-003-FHD33W
	9	—	0.75	PCS-009-FHD34D	PCS-009-FHD34W
	9	—	1	PCS-009-FHD35D	PCS-009-FHD35W
	9	—	1.5	PCS-009-FHD36D	PCS-009-FHD36W
	16	—	2	PCS-016-FHD37D	PCS-016-FHD37W
	16	—	3	PCS-016-FHD38D	PCS-016-FHD38W
	25	—	5	PCS-025-FHD39D	PCS-025-FHD39W
	37	—	7.5	PCS-037-FHD40D	PCS-037-FHD40W
	43	—	10	PCS-043-FHD41D	PCS-043-FHD41W
	60	—	15	PCS-060-FHD42D	PCS-060-FHD42W
	85	—	20	PCS-085-FHD43D	PCS-085-FHD43W
	85	—	25	PCS-085-FHD44D	PCS-085-FHD44W
	108	—	30	PCS-108-FHD45D	PCS-108-FHD45W
	135	—	40	PCS-135-FHD46D	PCS-135-FHD46W
	201	—	60	PCS-201-FHD48D	PCS-201-FHD48W
	251	—	75	PCS-251-FHD49D	PCS-251-FHD49W
	317	—	100	PCS-317-FHD50D	PCS-317-FHD50W
361	—	125	PCS-361-FHD51D	PCS-361-FHD51W	
480	—	150	PCS-480-FHD52D	PCS-480-FHD52W	
230	3	0.37	0.5	PCS-003-FAD33D	PCS-003-FAD33W
	9	0.55	0.75	PCS-009-FAD34D	PCS-009-FAD34W
	9	0.75	1	PCS-009-FAD35D	PCS-009-FAD35W
	9	1.1	1.5	PCS-009-FAD36D	PCS-009-FAD36W
	9	1.5	2	PCS-009-FAD37D	PCS-009-FAD37W
	16	2.2	3	PCS-016-FAD38D	PCS-016-FAD38W
	25	3.7	5	PCS-025-FAD39D	PCS-025-FAD39W
	30	5.5	7.5	PCS-030-FAD40D	PCS-030-FAD40W
	37	7.5	10	PCS-037-FAD41D	PCS-037-FAD41W
	43	11	15	PCS-043-FAD42D	PCS-043-FAD42W
	60	15	20	PCS-060-FAD43D	PCS-060-FAD43W
	85	18.5	25	PCS-085-FAD44D	PCS-085-FAD44W
	85	22	30	PCS-085-FAD45D	PCS-085-FAD45W
	108	30	40	PCS-108-FAD46D	PCS-108-FAD46W
	135	37	50	PCS-135-FAD47D	PCS-135-FAD47W
	201	55	75	PCS-201-FAD49D	PCS-201-FAD49W
	251	75	100	PCS-251-FAD50D	PCS-251-FAD50W
317	90	125	PCS-317-FAD51D	PCS-317-FAD51W	
361	110	150	PCS-361-FAD52D	PCS-361-FAD52W	
480	147	200	PCS-480-FAD54D	PCS-480-FAD54W	

Combination Fusible PCS Softstarters include:

- A fused switch with external operating handle
- A 120V control power transformer with fused primary and secondary
- PCS built-in electronic motor overload protection
- PCS built-in SCR bypass/run contactor
- Available in UL Type 12 or 4 Enclosures
- Terminal blocks for remote control devices

- ① Other UL type enclosures available. Contact your Sprecher + Schuh representative for pricing.
- ② See page D18 if ordering factory installed modifications.
- ③ The nominal current rating for the combination package may differ from the controller, based on the horsepower. Consult your Sprecher + Schuh representative.
- ④ Fuse clip accepts J-Type fuses. Power fuses are not supplied. See page D29 for Fusible Disconnect amp ratings.

- ⑤ For outdoor applications, replace "D" in catalog number with an "R". All enclosures are Type-12 with a Drip Shield. Example: PCS-085-FHD43D becomes PCS-085-FHD43R. **Price and dimensions remain the same.**
- ⑥ Motor FLA rating must fall within the specified current range for unit to operate properly. Special consideration should be given when using a motor with a potentially high starting current (greater than ten times motor FLA) with the PCS in the "Full Voltage" starting mode. The overload setting must be set to the motor FLA regardless if the Overload Function is "OFF" (disabled). Contact Sprecher+Schuh technical support for further guidance.

Enclosed Combination Fusible Starters - Line Connected ①②④⑦

Rated Voltage (V AC)	Current Rating (Amps) ⑥	Starting Duty		Type 12 [Type 3R ⑥] Industrial Dustight	Type 4 Watertight
		kW 50 Hz	Hp 60Hz	Catalog Number	Catalog Number
460 ⑤	3	0.37	0.5	PCS-003-FBD33D	PCS-003-FBD33W
	3	0.55	0.75	PCS-003-FBD34D	PCS-003-FBD34W
	3	0.75	1	PCS-003-FBD35D	PCS-003-FBD35W
	9	1.1	1.5	PCS-009-FBD36D	PCS-009-FBD36W
	9	1.5	2	PCS-009-FBD37D	PCS-009-FBD37W
	9	2.2	3	PCS-009-FBD38D	PCS-009-FBD38W
	16	3.7	5	PCS-016-FBD39D	PCS-016-FBD39W
	16	5.5	7.5	PCS-016-FBD40D	PCS-016-FBD40W
	25	7.5	10	PCS-025-FBD41D	PCS-025-FBD41W
	30	11	15	PCS-030-FBD42D	PCS-030-FBD42W
	37	15	20	PCS-037-FBD43D	PCS-037-FBD43W
	43	18.5	25	PCS-043-FBD44D	PCS-043-FBD44W
	43	22	30	PCS-043-FBD45D	PCS-043-FBD45W
	60	30	40	PCS-060-FBD46D	PCS-060-FBD46W
	85	37	50	PCS-085-FBD47D	PCS-085-FBD47W
	85	45	60	PCS-085-FBD48D	PCS-085-FBD48W
	108	55	75	PCS-108-FBD49D	PCS-108-FBD49W
	135	75	100	PCS-135-FBD50D	PCS-135-FBD50W
201	110	150	PCS-201-FBD52D	PCS-201-FBD52W	
251	132	200	PCS-251-FBD54D	PCS-251-FBD54W	
317	160	250	PCS-317-FBD56D	PCS-317-FBD56W	
361	200	300	PCS-361-FBD57D	PCS-361-FBD57W	
480	250	400	PCS-480-FBD59D	PCS-480-FBD59W	
575	3	0.55	0.75	PCS-003-FCD34D	PCS-003-FCD34W
	3	0.75	1	PCS-003-FCD35D	PCS-003-FCD35W
	9	1.1	1.5	PCS-009-FCD36D	PCS-009-FCD36W
	9	1.5	2	PCS-009-FCD37D	PCS-009-FCD37W
	9	2.2	3	PCS-009-FCD38D	PCS-009-FCD38W
	9	3.7	5	PCS-009-FCD39D	PCS-009-FCD39W
	16	5.5	7.5	PCS-016-FCD40D	PCS-016-FCD40W
	16	7.5	10	PCS-016-FCD41D	PCS-016-FCD41W
	25	11	15	PCS-025-FCD42D	PCS-025-FCD42W
	30	15	20	PCS-030-FCD43D	PCS-030-FCD43W
	37	18.5	25	PCS-037-FCD44D	PCS-037-FCD44W
	43	22	30	PCS-043-FCD45D	PCS-043-FCD45W
	43	30	40	PCS-043-FCD46D	PCS-043-FCD46W
	60	37	50	PCS-060-FCD47D	PCS-060-FCD47W
	85	45	60	PCS-085-FCD48D	PCS-085-FCD48W
	85	55	75	PCS-085-FCD49D	PCS-085-FCD49W
	108	75	100	PCS-108-FCD50D	PCS-108-FCD50W
	135	90	125	PCS-135-FCD51D	PCS-135-FCD51W
201	132	200	PCS-201-FCD54D	PCS-201-FCD54W	
251	160	250	PCS-251-FCD56D	PCS-251-FCD56W	
317	200	300	PCS-317-FCD57D	PCS-317-FCD57W	
361	250	350	PCS-361-FCD58D	PCS-361-FCD58W	
480	315	500	PCS-480-FCD61D	PCS-480-FCD61W	

Combination Fusible PCS Softstarters include:

- A fused switch with external operating handle
- A 120V control power transformer with fused primary and secondary
- PCS built-in electronic motor overload protection
- PCS built-in SCR bypass/run contactor
- Available in UL Type 12 or 4 Enclosures
- Terminal blocks for remote control devices

D PCS Softstarters

- ① Other UL type enclosures available. Contact your Sprecher + Schuh representative.
- ② See page D18 if ordering factory installed modifications.
- ③ The nominal current rating for the combination package may differ from the controller, based on the horsepower. Consult your Sprecher + Schuh representative.
- ④ Fuse clips accept J-Type fuses. Power fuses are not supplied. See page D29 for Fusible Disconnect amp ratings.
- ⑤ For 380V applications choose softstarter based on FLA, then change the FB code in the catalog number to FG. Example PCS-043-FBD44D becomes PCS-043-FGD44D, which covers 25 HP @ 380V FLA 37. **Price remains the same.**

- ⑥ For outdoor applications, replace "D" in catalog number with an "R". All enclosures are Type-12 with a Drip Shield. For example number PCS-085-FBD47D becomes PCS-085-FBD47R. **Price and dimensions remain the same.**
- ⑦ Motor FLA rating must fall within the specified current range for unit to operate properly. Special consideration should be given when using a motor with a potentially high starting current (greater than ten times motor FLA) with the PCS in the "Full Voltage" starting mode. The overload setting must be set to the motor FLA regardless if the Overload Function is "OFF" (disabled). Contact Sprecher+Schuh technical support for further guidance.





Options - Factory Modifications

Description	Catalog Number
Pushbuttons (2) START and STOP pushbuttons for enclosed softstarters	Add suffix " -3 "
Selector Switch Two or three position selector switch for enclosed softstarters "ON-OFF" "HAND-OFF-AUTO"	Add suffix " -6 " Add suffix " -7 "
Pilot Light  Red pilot light with "RUN" inscription for enclosed softstarters	Add suffix " -1 "
Voltmeter (Panelboard) Measures all three phases. Includes switch.	Add suffix " -VM3 "
Ammeter (Panelboard) For monitoring all three phases. Includes switch.	Add suffix " -AM3 "
Elapsed Time Meter Measures elapsed motor running time	Add suffix " -ETM "



D
PCS Softstarters

 When adding Pilot Lights plus other cover controls, add the Pilot Light first. For example; to add a Start-Stop Pushbutton and a Pilot Light, add **-13** at the end of the part number, not **-31**.

Auxiliary Contact Blocks (1 & 2 Pole) ①

Contact Block	Description	NO	NC	Contact Arrangement	For use with...	Catalog Number
	<ul style="list-style-type: none"> For side mounting with sequence terminal designations Snap-on design – mounts without tools One block per device only 	1	0		All PCS & PCEC Controllers	PCS-PA-10
		2	0			PCS-PA-20
		0	1			PCS-PA-01
		1	1			PCS-PA-11

Accessories

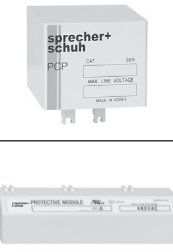
Accessory	Description	For use with...	Catalog Number
 <p>PCV-064</p>	<p>Internal PCS Fan</p> <ul style="list-style-type: none"> Attaches directly to PCS Controller Recommended for enclosed PCS-003...37A Controllers Fan is included as standard on PCS-043...480A devices For PCS-108...480A units, separate 120V or 240V single phase is required for fan operation. 	PCS-003...037 PCE-032...064-600V	PCV-064
		PCS-043...085 PCE-074...147-600V	PCV-147
		PCS-108...135 PCE-234-600V	PCV-234
		PCS-201...251	PFV-0251
		PCS-317...480	PFV-0480
	<p>Connecting Module</p> <ul style="list-style-type: none"> For direct connection of PCS Controller to KT7 Motor Circuit Controller Motor Circuit Controller and PCS Controller must each be mounted See Section F for KT7 Mounting Modules 	KT7-25S to PCS-003...025	PCS-25S-CC25
		KT7-25H to PCS-003...025	PCS-25H-CD25
		KT7-45H to PCS-003...037	PCS-45H-CF45
	<p>Connecting Module</p> <ul style="list-style-type: none"> For direct connection of PCS Controller to CA7 contactor CA7 Contactor and PCS Controller must each be mounted See Section F for KT7 Mounting Modules 	CA7-9...23 to PCS-003...019	PCS-23-CI23
		CA7-30...37 to PCS-003...037	PCS-37-CI37
	<p>600V Protective Module</p> <ul style="list-style-type: none"> Protects power components from transient voltage spikes and shunts noise energy away from the controller electronics PCS (3 Lead) Line Connected Applications: Protective modules may be installed on the line and/or load side PCS (6 Lead) Delta Connected Applications: Protective modules must be installed on the line side only Clamping voltage range 705V...1750V, energy rating 290 joules 	PCS-003...037-600V PCE-032...064-600V	PCP-064-600V
		PCS-043...085-600V PCE-074...147-600V	PCP-147-600V
		PCS-108...480 PCE-234-600V	PFV-0480-600V

① One Auxiliary Contact block (one or two pole) may be mounted on the right side of the controller.



IEC Terminal Covers ①

	Description		Pkg. Qty.	Catalog Number
	IEC line or load terminal covers for 108...135A devices. Dead front protection		1	PFT-0135
	IEC line or load terminal covers for 201...251A devices. Dead front protection			PFT-0251
	IEC line or load terminal covers for 317...480A devices. Dead front protection			PFT-0480

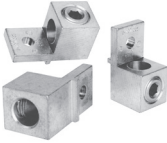

Terminal Lug Kits (108...480 A)

	Current Rating (A)	Conductor Size	Total No. of Line Controller Terminal Lugs Possible Each Side		Pkg. Qty.	Catalog Number
			Line Side	Load Side		
	108...135	#6...250 MCM AWG 16 mm ² ...120mm ²	3	3	3	PNX-1120
201...251	#4...500 MCM AWG 25 mm ² ...240MM ²	6	6			
317...480	#4...500 MCM AWG 25 mm ² ...240MM ²	6	6			

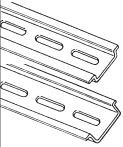
Accessories

Accessory	Description	For Use With...	Catalog Number
	Remote Reset Solenoid - For remote resetting of the PCS electronic overload	PCS	CMR7- * <i>Replace * with coil code below</i>
	External Reset Button - Used for manually resetting the PCS electronic overload	All PCS Controllers	Use D7 Reset See Section H
	DIN-rail - 2 meter lengths (6' 6") Top Hat, low profile (price per rail) Top Hat, high profile (price per rail)		3F 3AF

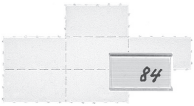
Marking Systems

Component	Description	Pkg. Qty.	Catalog Number
	Label Sheet - 1 sheet with 105 self-adhesive paper labels each, 6 x 17mm	1	CA7-FMS
	Marking Tag Sheet - 1 sheet with 160 perforated paper labels each, 6 x 17mm. To be used with transparent cover.	1	CA7-FMP
	Transparent Cover - To be used with Marking Tag Sheets.	100 ②	CA7-FMC
	Tag Carrier - For marking with Series V7 Clip-on Tags.	100 ②	CA7-FMA2

CMR7 Remote Reset Coil Codes

AC Coil Code	Voltage Range		
	50 Hz	60 Hz	50 / 60 Hz
24Z	~	~	24V
120	110V	120V	
240	220V	230V	

DC Coil Code	Voltage
24D	24VDC
48D	48VDC
115D	115VDC

① PCS-108...480A units include one terminal cover as standard.

② Minimum order quantity is one package of 100. Price each x 100 = package price.

Control Modules

PCS Rating	For units rated 200...600V AC ④			
	100...240V AC Catalog Number	Qty	24V AC/DC Catalog Number	Qty
108 A	PCS-108	1	PCS-108-024	1
135 A	PCS-135	1	PCS-135-024	1
201 A	PCS-201	1	PCS-201-024	1
251 A	PCS-251	1	PCS-251-024	1
317 A	PCS-317	1	PCS-317-024	1
361 A	PCS-361	1	PCS-361-024	1
480 A	PCS-480	1	PCS-480-024	1

Power Poles ①

PCS Rating	For units rated 200...600V AC ④	
	200...600V AC Catalog Number	Qty
108 A	PFL-0108-600V ②	1
135 A	PFL-0135-600V ②	1
201 A	PFL-0201-600V ③	1
251 A	PFL-0251-600V ③	1
317 A	PFL-0317-600V ③	1
361 A	PFL-0361-600V ③	1
480 A	PFL-0480-600V ③	1

Each power pole contains two SCR's and one bypass contactor power pole. The PCS requires three power poles. For example: the replacement power pole for a PCS-0108-600V is PFL-0108-600V

- ① One piece provided per part number.
- ② Part number contains three power poles.
- ③ Part number contains one power pole.
- ④ Control Modules and Power Poles are not replaceable for PCS-003...85.

Standard Features	
Selectable Start Times	2, 5, 10, 15, 20, 25, or 30 s
Selectable Initial Torque	15%, 25%, 35%, and 65% of locked rotor torque
Selectable Current Limit	150%, 250%, 350%, and 450% of full load current
Selectable Kick Start - 450% FLA	0, 0.5, 1.0, or 1.5 s
Selectable Soft Stop	Off, 100%, 200%, or 300% of the start time setting when wired

Electrical Ratings				
	UL/CSA/NEMA	IEC		
Rated Operation Voltage	200...600V AC (+10%, -15%)	500V~ — 500V~		
Rated Insulation Voltage	600V AC	500V~		
Dielectric Withstand	2200V AC	2500V~		
Repetitive Peak	200...600V AC: 1600V	500V~: 1600V		
Operating Frequency	50/60 Hz	50/60 Hz		
Power Circuit	Utilization Category	1...37 A	—	AC-53b: 3.5-15:3585
		43...60 A	—	AC-53b: 4.5-30:1770
		85 A	—	AC-53b: 4.5-30:3570
		108 A	—	AC-53b: 4.5-30:1770
		135 A	—	AC-53b: 3.5-30: 1770
		201...251 A	—	AC-53b: 3.5-30: 1770
		317...480 A	—	AC-53b: 3.5-30: 1770
Number of Poles	Equipment designed for 3-phase only			
Rated Impulse Voltage	6 kV			
DV/DT Protection	1000V/μs			
Overvoltage Category	III			

SCPD Performance		Type 1 ②					
		Non-Time Delay Fuses (K5)		Thermal Magnetic Circuit Breaker		High Capacity Time Delay Class CC/J/L	
SCPD List ①		Max. Standard Available Fault	Max. Standard Fuse (A)	Max. Standard Available Fault	Max. Circuit Breaker (A)	Max. Standard Available Fault	Max. Circuit Fuse (A)
Line Device Operational Current Rating (A)	3	5 kA	12	5 kA	15	70 kA	6
	9	5 kA	30	5 kA	30	70 kA	15
	16	5 kA	60	5 kA	60	70 kA	30
	19	5 kA	70	5 kA	70	70 kA	40
	25	5 kA	100	5 kA	100	70 kA	50
	30	10 kA	110	10 kA	110	70 kA	60
	37	10 kA	125	10 kA	125	70 kA	60
	43	10 kA	150	10 kA	150	70 kA	90
	60	10 kA	225	10 kA	225	70 kA	125
	85	10 kA	300	10 kA	300	70 kA	175
	108	10 kA	400	10 kA	300	70 kA	200
	135	10 kA	500	10 kA	400	70 kA	225
	201	18 kA	600	18 kA	600	70 kA	350
	251	18 kA	700	18 kA	700	70 kA	400
	317	30 kA	800	30 kA	800	69 kA	500
	361	30 kA	1000	30 kA	1000	69 kA	600
	480	42 kA	1200	42 kA	1200	69 kA	800
Delta Device Operational Current Rating (A)	5.1	5 kA	15	5 kA	15	70 kA	10
	16	5 kA	60	5 kA	60	70 kA	30
	27.6	5 kA	70	5 kA	70	70 kA	60
	32.8	5 kA	125	5 kA	125	70 kA	70
	43	5 kA	150	5 kA	150	70 kA	90
	52	10 kA	200	10 kA	200	70 kA	100
	64	10 kA	250	10 kA	250	70 kA	100
	74	10 kA	250	10 kA	250	70 kA	150
	104	10 kA	400	10 kA	300	70 kA	225
	147	10 kA	400	10 kA	400	70 kA	300
	187	10 kA	600	10 kA	500	70 kA	400
	234	10 kA	700	10 kA	700	70 kA	400
	348	18 kA	1000	18 kA	1000	70 kA	600
	435	18 kA	1200	18 kA	1200	69 kA	800
	549	30 kA	1600	30 kA	1600	69 kA	1000
	625	30 kA	1600	30 kA	1600	69 kA	1200
	831	42 kA	1600	30 kA	1600	69 kA	1600
831	42 kA	1600	42 kA	1200	69 kA	1600	

① Consult local codes for proper sizing of short circuit protection.

② Type 1 performance/protection indicates that, under a short-circuit condition, the fused or circuit breaker-protected starter shall cause no danger to persons or installation but may not be suitable for further service without repair or replacement.

Electrical Ratings			
		UL/CSA/NEMA	IEC
Control Circuit	Rated Operational Voltage (+10%, -15%)	100...240V AC, 24V AC/DC	100...240V AC, 24V AC/DC
	Rated Insulation Voltage	250V	250V-
	Rated Impulse Voltage	2.5 kV	4 kV
	Dielectric Withstand	1500V AC	2000V-
	Overvoltage Category	II	III ①
	Operating Frequency	50/60 Hz	50/60 Hz
	Input on state voltage minimum, during start (IN1, IN2)	85V AC, 19.2V DC / 19.2V AC	
	Input on state current (IN1, IN2)	9.8 mA @120V AC/19.6 mA @ 240V AC, 7.3 mA @ 24V AC/DC	
	Input off state voltage maximum (IN1, IN2)	40V AC, 17V DC / 12V AC	
	Input off state current @ input off state voltage (IN1, IN2)	<10 mA, <12 mA	
Control Power with Fan, during start	3...37 A	215 mA @ 120V AC / 180 mA @ 240V AC, 800 mA @ 24V DC / 660 mA @ 24V AC	
	43...85 A	200 mA @120V AC / 100 mA @240V AC, 700 mA @ 24V AC/DC	
		Fan Power	Control Power
	108...135 A	20 VA	200 mA @120V AC / 120 mA @ 240V AC, 600 mA @24V AC/DC
	201...251 A	40 VA	
317...480 A	60 VA		
Control Power without Fan, during start	3...37 A	205 mA @120V AC / 145 mA @240V AC, 705 mA @ 24V DC / 580 mA @24V AC	
Steady State Heat Dissipation and Overload Current Range	Controller Rating (A)	Steady State Heat Dissipation (W)	
	3	11	
	9	12	
	16	14	
	19	15	
	25	17	
	30	19	
	37	24	
	43	34	
	60	50	
	85	82	
	108	62	
	135	75	
	201	129	
	251	147	
	317	174	
361	194		
480	239		
		Overload Current Range (A)	
		1.3	
		3.9	
		5.3...16	
		6.3...19	
		9.2...27.7	
		10...30	
		12.3...37	
		14.3...43	
		20...60	
		28.3...85	
		27...108	
		34...135	
		67...201	
		84...251	
		106...317	
		120...361	
		160...480	

Auxiliary Contacts			
		UL/CSA/NEMA	IEC
Rated Operational Voltage		250V AC/30V DC	250V~/30V DC
Rated Insulation Voltage		250V	250V~
Rated Impulse Voltage		2.5 kV	4 kV
Dielectric Withstand		1500V AC	2000V~
Overvoltage Category		II	III ①
Operating Frequency		50/60 Hz	50/60 Hz
Utilization Category		D300/D300	AC15
TB-97, -98 (OVL/D/Fault)	Type of Control Circuit	Electromagnetic relay	
	Number of Contacts	1	
	Type of Contacts	Normally Open (N.O.)	
	Type of Current	AC/DC	
	Rated Operational Current (max.)	0.6 A @ 120V ~ and 0.3 A @ 240V-	
	Conventional Thermal Current I_{th}	1 A	
	Make/Break VA	432/72	
TB-13, -14 (Normal/Up-to-Speed)	Type of Control Circuit	Electromagnetic relay	
	Number of Contacts	1	
	Type of Contacts	Normally Open (N.O.)	
	Type of Current	AC/DC	
	Rated Operational Current (max.)	0.6 A @ 120V ~ and 0.3 A @ 240V-	
	Conventional Thermal Current I_{th}	1 A	
	Make/Break VA	432/72	

① Overvoltage category II, when either control or auxiliary circuit is wired to a SELV or PELV circuit.

Electrical Ratings		
Side-Mount Auxiliary Contacts		
	UL/CSA/NEMA	IEC
Rated Operational Voltage	250V AC/30V DC	250V/30V DC
Rated Insulation Voltage	250V	250V AC
Rated Impulse Voltage	2.5 kV	4 kV
Dielectric Withstand	1500V AC	2000V AC
Overvoltage Category	II	III ^①
Operating Frequency	50/60 Hz	50/60 Hz
	Utilization Category	C300/R150
	Type of Control Circuit	Electromagnetic relay
	Number of Contacts	1
	Type of Contacts	Normally Open (N.O.)
	Type of Current	AC/DC
	Rated Operational Current (max.)	1.5 A @ 120V AC, 0.75A @ 240V AC, 1.17 A @ 24V DC
	Conventional Thermal Current I_{th}	2.5 A
	Make/Break VA	1800/180V AC, 28V DC (resistive)
	Type of Control Circuit	B300/R300
	Type of Control Circuit	Electromagnetic relay
	Number of Contacts	1
	Type of Contacts	Normally Open (N.O.)
	Type of Current	AC/DC
	Rated Operational Current (max.)	3 A @ 120V AC, 1.5A @ 240V AC, 1.17 A @ 24V DC
	Conventional Thermal Current I_{th}	5 A
	Make/Break VA	3600/360 V AC, 28V DC (resistive)

Environmental	
Operating Temperature Rating	-5...50 °C (23...122 °F) (open) -5...40 °C (23...104 °F) (enclosed)
Storage and Transportation Temperature Range	-25...85 °C (-13...185 °F)
Altitude	2000 m (6560 ft)
Humidity	5...95% (non-condensing)
Pollution Degree	2
Type of Protection	IP2X

Mechanical Ratings			
Resistance to Vibration	Operational	1.0 G Peak, 0.15 mm (0.006 in.) displacement	
	Non-operational	2.5 G Peak, 0.38 mm (0.015 in.) displacement	
Resistance to Shock	Operational	15 G	
	Non-operational	30 G	
Line Power Terminals	Cable Size Tightening Torque	3...37 A	2.5...25 mm ² (14...4 AWG) 2.3...2.8 N•m (20...25 in-lbs)
		43...85 A	2.5...95 mm ² (14...3/0 AWG) 11.3...12.4 N•m (100...110 in-lbs)
		108...135 A	16.9 N•m (150 in-lbs)
		201...251 A	Two M10 x 1.5 diameter holes per power pole
		317...480 A	Two M12 x 1.75 diameter holes per power pole
Load Power Terminals	Cable Size Tightening Torque	3...37 A	2.5...16 mm ² (14...6 AWG) 2.3...2.5 N•m (20...22.5 in-lbs)
		43...85 A	2.5...50 mm ² (14...1 AWG) 11.3...12.4 N•m (100...110 in-lbs)
		108...135 A	23 N•m (200 in-lbs)
		201...251 A	Two M10 x 1.5 diameter holes per power pole
		317...480 A	Two M12 x 1.75 diameter holes per power pole
Control Terminals	Cable Size Tightening Torque	All	0.2...2.5 mm ² (24...14 AWG) 0.5...0.9 N•m (4.4...8.0 in-lbs)

Other			
	UL/CSA/NEMA	IEC	
EMC Emissions Levels	Conducted Radio Frequency Emissions	—	Class A
	Radiated Emissions	—	Class A
EMC Immunity Levels	Electrostatic Discharge	4 kV Contact and 8 kV Air Discharge	8 kV Air Discharge
	Radio Frequency Electromagnetic Field	—	Per EN/IEC 60947-4-2
	Fast Transient	—	Per EN/IEC 60947-4-2
	Surge Transient	—	Per EN/IEC 60947-4-2

① Overvoltage category II, when either control or auxiliary circuit is wired to a SELV or PELV circuit.

Overload Relay Trip Curves

— Hot — Cold

Trip Class 10

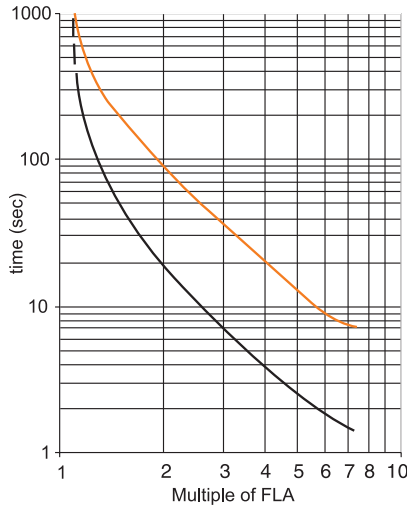

Trip Class 15

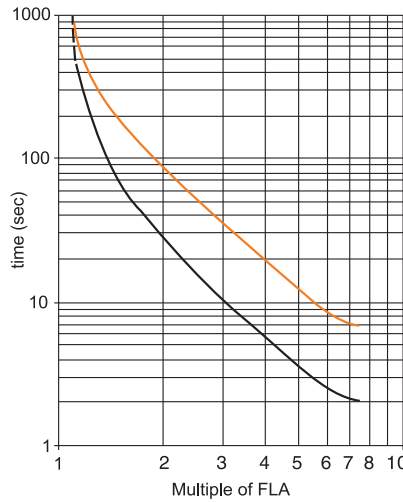

Trip Class 20

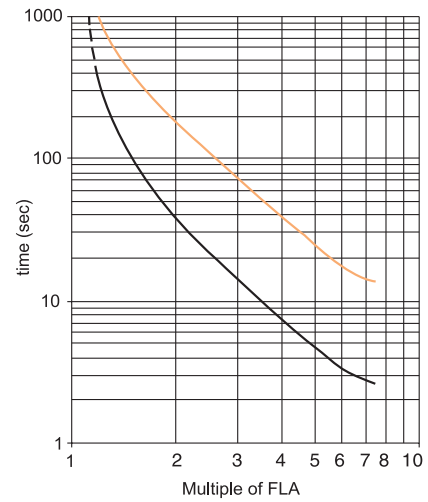

Starts per Hour Curves

PCS Controller - Starts per hour
40C, 100% duty cycle, 10 sec., 350%, no fan

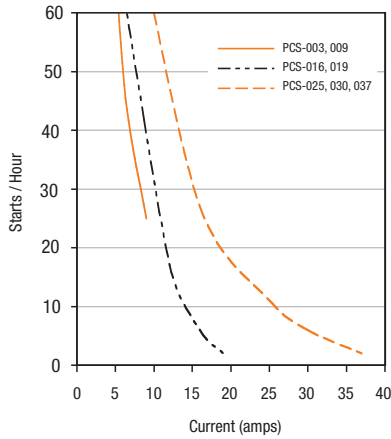

PCS Controller - Starts per hour
40C, 100% duty cycle, 10 sec., 350%, with fan

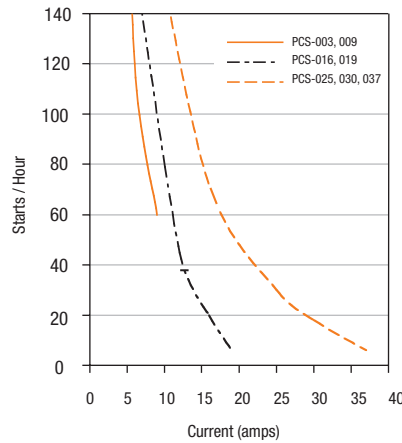

PCS Controller - Starts per hour
40C, 100% Duty Cycle, 20sec, 350% (with standard fan)

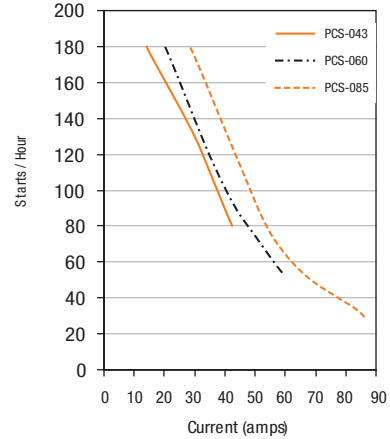

PCS Controller Starts per hour (108-135A)
40C, 100% Duty Cycle, 20 sec, 350% (with standard fan)

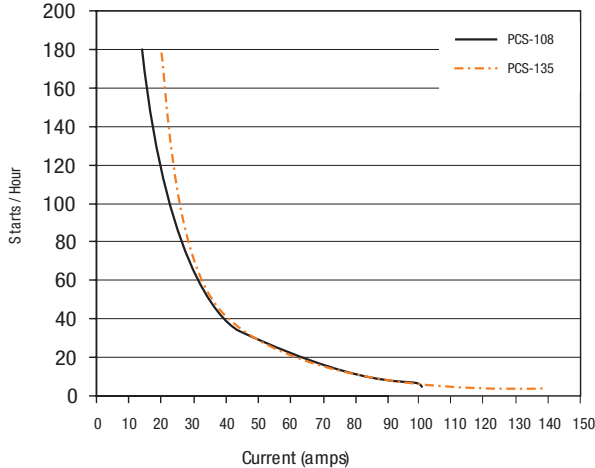

PCS Controller Starts per hour (201...480 A)
40C, 100% Duty Cycle, 20 sec, 350% (with standard fan)

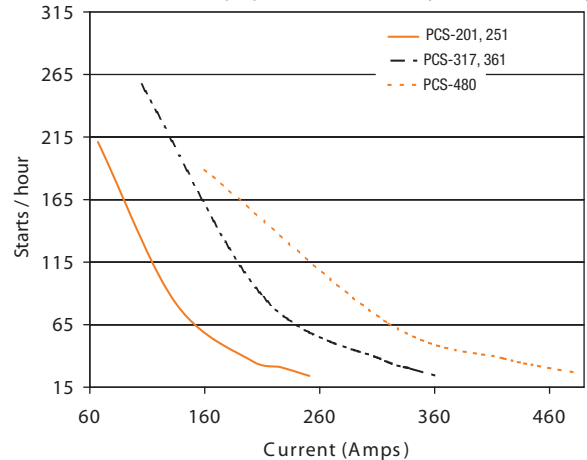

D
PCS Softstarters

Two Wire Configuration

Line Connected ①

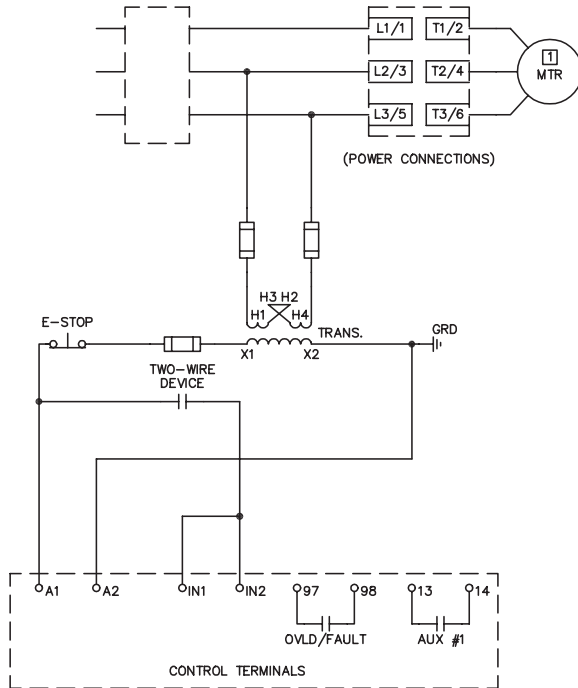

Delta Connected ①

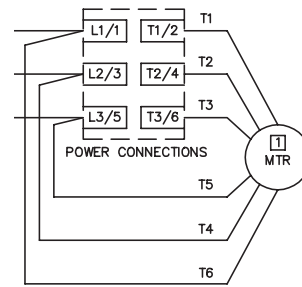

- ① Line or Delta Connected selection are determined by the customer.
- PCS DIP Switch #15 "ON": PCS set for Line Connected Motors
 - PCS DIP Switch #15 "OFF": PCS set for Delta Connected Motors

Three Wire Configuration

Line Connected ①

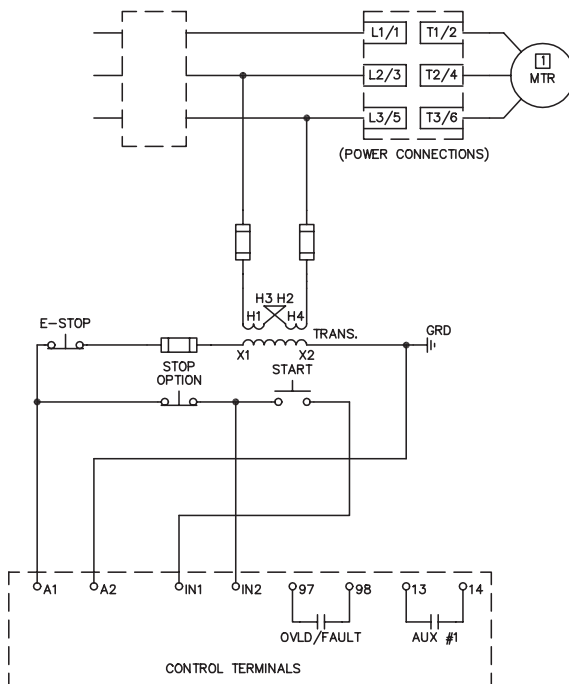

Delta Connected ①

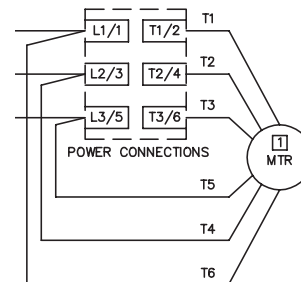

- ① Line or Delta Connected selection are determined by the customer.
- PCS DIP Switch #15 "ON": PCS set for Line Connected Motors
 - PCS DIP Switch #15 "OFF": PCS set for Delta Connected Motors

Isolation Contactor Configuration

Line Connected ①

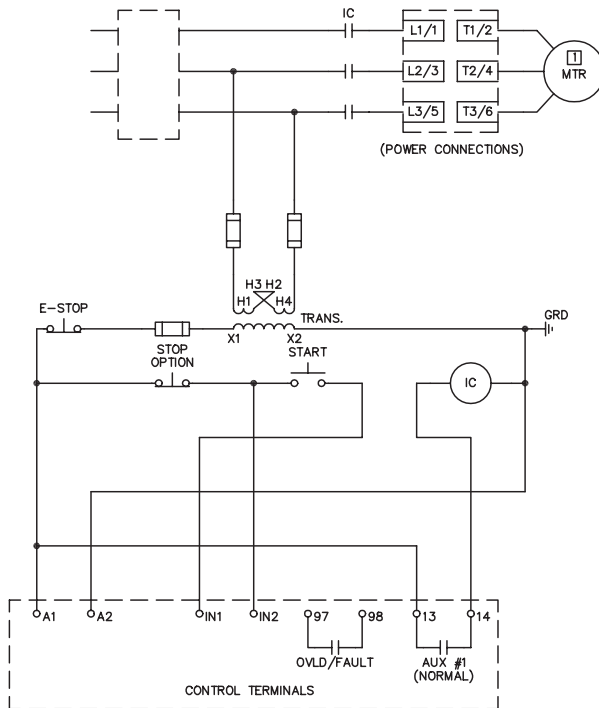

Delta Connected ①

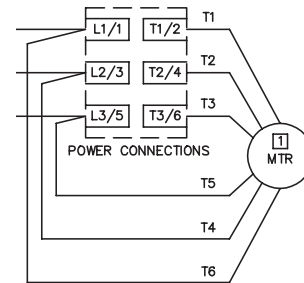

- ① Line or Delta Connected selection are determined by the customer.
- PCS DIP Switch #15 "ON": PCS set for Line Connected Motors
 - PCS DIP Switch #15 "OFF": PCS set for Delta Connected Motors

Reversing Configuration

Line Connected ①

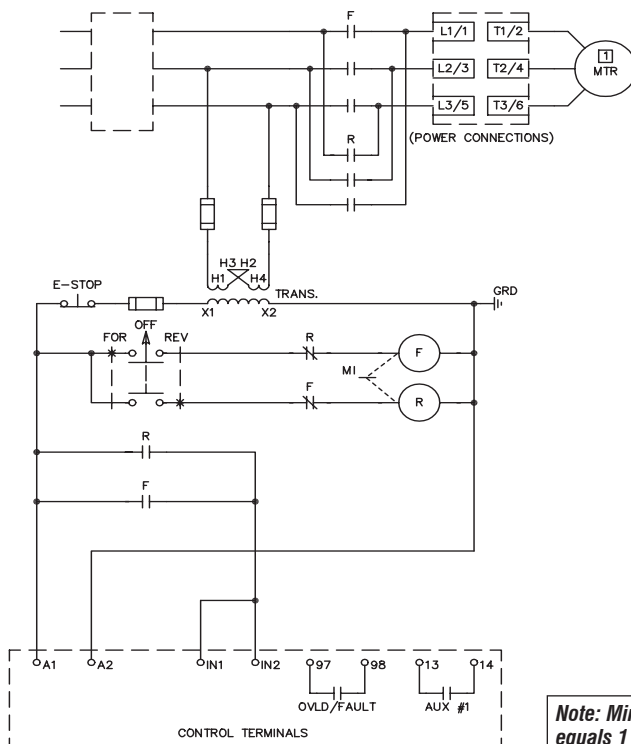

Delta Connected ①

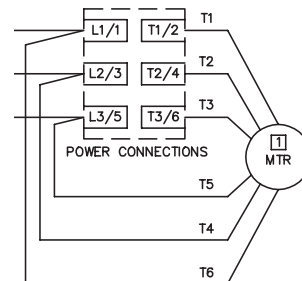

- ① Line or Delta Connected selection are determined by the customer.
- PCS DIP Switch #15 "ON": PCS set for Line Connected Motors
 - PCS DIP Switch #15 "OFF": PCS set for Delta Connected Motors

Note: Minimum off time equals 1 second

D
PCS Softstarters

PCS Softstarter Controller

Dimensions are in millimeters (inches). Dimensions not intended for manufacturing purposes.

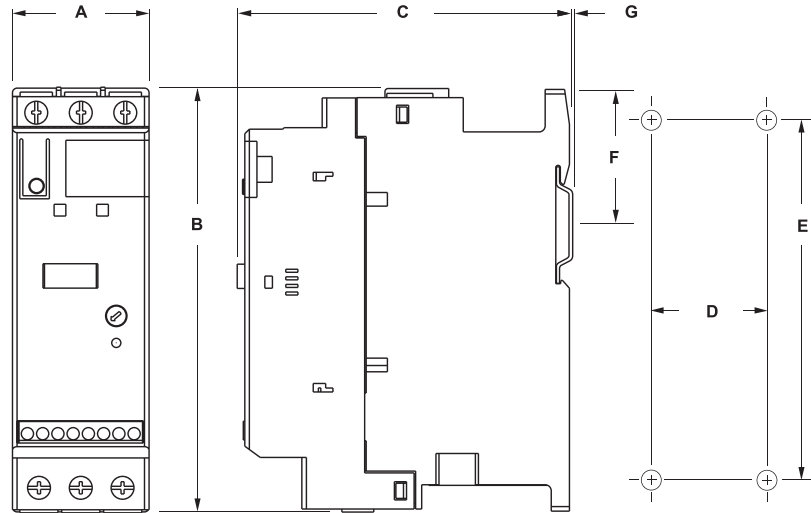

Controller	A	B	C	D	E	F	G	Mounting Hole Size	Weight (kg (lbs))
3...37A	44.8 (1-49/64)	139.7 (5-1/2)	100 (4-21/64)	35 (1-3/8)	132 (5-13/64)	46.4 (1-13/16)	2 (1/16)	4.6 (0.18)	0.86 (1.9)
43...85A	72 (2-26/32)	206 (8-1/8)	130 (5-1/8)	55 (2-5/32)	198 (7-25/32)	102 (4)	2 (1/16)	5.3 (0.21)	2.25 (5.0)
108...135A	196.4 (7.74)	443.7 (17.47)	205.2 (8.08)	166.6 (6.56)	367 (14.45)	~	~	7.5 (0.295)	15 (33)
201...251	225 (8.86)	560 (22.05)	265.3 (10.45)	150 (5.91)	504.1 (19.85)	~	~	11.5 (0.45)	30.4 (67)
317...480	290 (11.42)	600 (23.62)	298 (11.73)	200 (7.87)	539 (21.23)	~	~	11.5 (0.45)	45.8 (101)

Minimum Enclosure Size

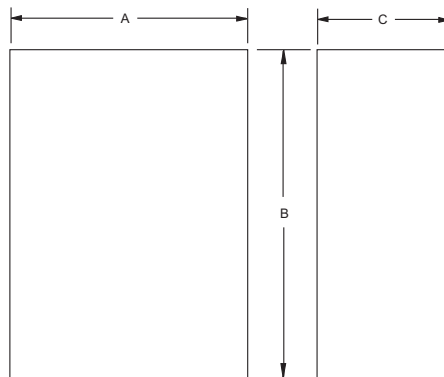

Controller	Height B	Width A	Depth C	Fan Requirements
3...37 A	305 (12)	224 (9)	152 (6)	none
43...85 A	406 (16)	305 (12)	203 (8)	none
108...135 A	762 (30)	610 (24)	305 (12)	none
201...251 A	965 (38)	762 (30)	356 (14)	none
317...480 A	1295 (51)	914 (36)	356 (14)	none

Enclosed Type Line-Connected Controllers

IMPORTANT NOTE:

Factory installed options may affect enclosure size requirements. Exact dimensions can be obtained after order entry. Consult your local Sprecher + Schuh representative.

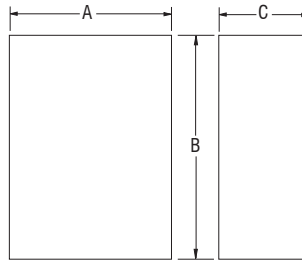

Dimensions are in millimeters (inches). Dimensions not intended for manufacturing purposes.

Controller Rating (A)	Disconnect Rating	IP65 (Type 4/12)		
		B Height	A Width	C Depth
Non-Combination Controller				
3	—	356 (14)	305 (12)	152 (6)
9	—	356 (14)	305 (12)	152 (6)
16	—	356 (14)	305 (12)	152 (6)
25	—	356 (14)	305 (12)	152 (6)
30	—	356 (14)	305 (12)	152 (6)
37	—	356 (14)	305 (12)	152 (6)
43	—	406 (16)	356 (14)	203 (8)
60	—	406 (16)	356 (14)	203 (8)
85	—	406 (16)	356 (14)	203 (8)
108	—	762 (30)	610 (24)	305 (12)
135	—	762 (30)	610 (24)	305 (12)
201	—	914 (36)	762 (30)	406 (16)
251	—	914 (36)	762 (30)	406 (16)
317	—	1524 (60)	914 (36)	406 (16)
361	—	1524 (60)	914 (36)	406 (16)
480	—	1524 (60)	914 (36)	406 (16)
Combination Controllers with Fusible Disconnect				
3	30 A/J	508 (20)	406 (16)	203 (8)
9	30 A/J	508 (20)	406 (16)	203 (8)
16	30 A/J	508 (20)	406 (16)	203 (8)
25	30 A/J	508 (20)	406 (16)	203 (8)
30	60 A/J	508 (20)	406 (16)	203 (8)
37	60 A/J	508 (20)	406 (16)	203 (8)
43	60 A/J	610 (24)	508 (20)	203 (8)
60	100 A/J	610 (24)	508 (20)	254 (10)
85 ①	100 A/J	610 (24)	508 (20)	254 (10)
85 ②	200 A/J	762 (30)	610 (24)	305 (12)
108	200 A/J	914 (36)	762 (30)	406 (16)
135	200 A/J	914 (36)	762 (30)	406 (16)
201	400 A/J	1219 (48)	914 (36)	406 (16)
251	400 A/J	1219 (48)	914 (36)	406 (16)
317	600 A/J	1524 (60)	914 (36)	406 (16)
361	600 A/J	1524 (60)	914 (36)	406 (16)
480	600 A/J	1524 (60)	914 (36)	406 (16)
Combination Controllers with Circuit Breaker				
3	15 A	508 (20)	406 (16)	203 (8)
9	15 A	508 (20)	406 (16)	203 (8)
16	20 A	508 (20)	406 (16)	203 (8)
25	30 A	508 (20)	406 (16)	203 (8)
30	40 A	508 (20)	406 (16)	203 (8)
37	50 A	508 (20)	406 (16)	203 (8)
43	80 A	610 (24)	508 (20)	203 (8)
60	100 A	610 (24)	508 (20)	254 (10)
85	125 A	610 (24)	508 (20)	254 (10)
108	175 A/175 A Plug	914 (36)	762 (30)	406 (16)
135	225 A/225 A Plug	914 (36)	762 (30)	406 (16)
201	300 A/300 A Plug	1219 (48)	914 (36)	406 (16)
251	400 A/400 A Plug	1219 (48)	914 (36)	406 (16)
317	600 A/600 A Plug	1524 (60)	914 (36)	406 (16)
361	600 A/600 A Plug	1524 (60)	914 (36)	406 (16)
480	800 A/800 A Plug	1524 (60)	914 (36)	406 (16)

① Dimensions for FHD-43, FAD-44, FBD-47, and FCD-48.
 ② Dimensions for FHD-44, FAD-45, FBD-48, and FCD-49.

D
PCS Softstarters

